

ECS455: Chapter 5

OFDM

Dr. Prapun Suksompong
prapun.com/ecs455

Office Hours:

BKD 3601-7

Wednesday 15:30-16:30

Friday 9:30-10:30

OFDM Applications

- 802.11 **Wi-Fi**: a and g versions
- DVB-T (the terrestrial digital TV broadcast system used in most of the world outside North America)
- DMT (the standard form of **ADSL** - Asymmetric Digital Subscriber Line)
- **WiMAX, LTE**

Wireless	Wireline
IEEE 802.11a, g, n (WiFi) Wireless LANs	ADSL and VDSL broadband access via POTS copper wiring
IEEE 802.15.3a Ultra Wideband (UWB) Wireless PAN	MoCA (Multi-media over Coax Alliance) home networking
IEEE 802.16d, e (WiMAX), WiBro, and HiperMAN Wireless MANs	PLC (Power Line Communication)
IEEE 802.20 Mobile Broadband Wireless Access (MBWA)	
DVB (Digital Video Broadcast) terrestrial TV systems: DVB-T, DVB-H, T-DMB, and ISDB-T	
DAB (Digital Audio Broadcast) systems: EUREKA 147, Digital Radio Mondiale, HD Radio, T-DMB, and ISDB-TSB	
Flash-OFDM cellular systems	
3GPP UMTS & 3GPP@ LTE (Long-Term Evolution) and 4G	

OFDM: Overview (1)

- Let $\underline{s} = (s_1, s_2, \dots, s_N)$ be the information symbol.



OFDM: Overview (2)

- Let $\underline{S} = (S_1, S_2, \dots, S_N)$ be the information symbol.
- The discrete baseband OFDM modulated symbol can be expressed as

$$s(t) = \frac{1}{\sqrt{N}} \sum_{k=0}^{N-1} S_k \exp\left(j \frac{2\pi kt}{T_s}\right), \quad 0 \leq t \leq T_s$$

$$= \sum_{k=0}^{N-1} S_k \underbrace{\frac{1}{\sqrt{N}} 1_{[0, T_s]}(t)}_{c_k(t)} \exp\left(j \frac{2\pi kt}{T_s}\right)$$

Some references may use different constant in the front

Some references may start with different time interval, e.g. $[-T_s/2, +T_s/2]$

Note that:

$$\operatorname{Re}\{s(t)\} = \frac{1}{\sqrt{N}} \sum_{k=0}^{N-1} \left(\operatorname{Re}\{S_k\} \cos\left(\frac{2\pi kt}{T_s}\right) - \operatorname{Im}\{S_k\} \sin\left(\frac{2\pi kt}{T_s}\right) \right)$$

Single-User OFDM

**In this section,
we shall focus on the
Single-user case of OFDM.**

Motivation

Why do we need OFDM?

- First, we study the wireless channel.
- There are a couple of difficult problems in communication system over wireless channel.
- Also want to achieve high data rate (throughput)

ECS455: Chapter 5

OFDM

5.1 Wireless Channel

Dr. Prapun Suksompong
prapun.com/ecs455

Office Hours:

BKD 3601-7

Wednesday 15:30-16:30

Friday 9:30-10:30

Single Carrier Transmission

- Baseband:

$$s(t) = \sum_{k=0}^{N-1} s_k p(t - kT_s)$$

$$p(t) = 1_{[0, T_s)}(t) = \begin{cases} 1, & t \in [0, T_s) \\ 0, & \text{otherwise.} \end{cases}$$

- Passband:

$$x(t) = \text{Re}\{s(t)e^{j2\pi f_c t}\}$$

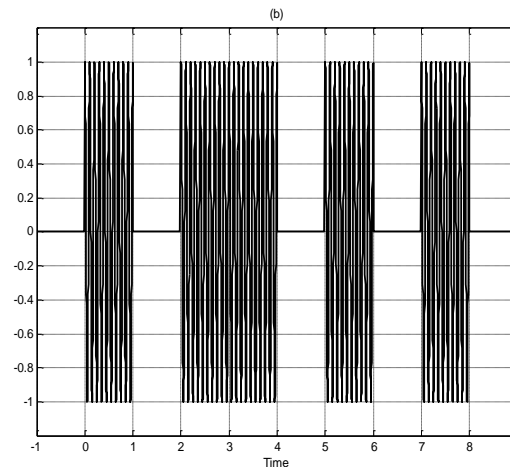
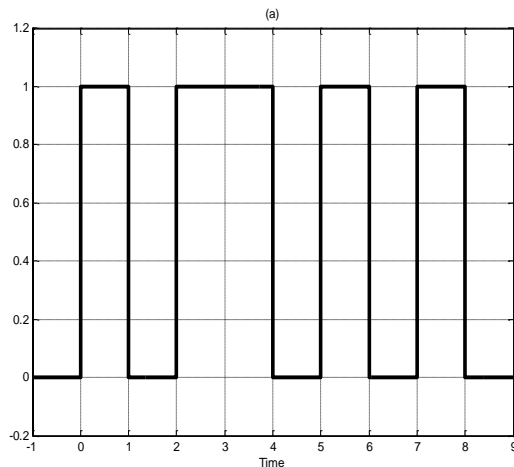

Multipath Propagation

- In a wireless mobile communication system, a transmitted signal propagating through the wireless channel often encounters multiple reflective paths until it reaches the receiver
- We refer to this phenomenon as **multipath propagation** and it causes fluctuation of the amplitude and phase of the received signal.
- We call this fluctuation **multipath fading**.

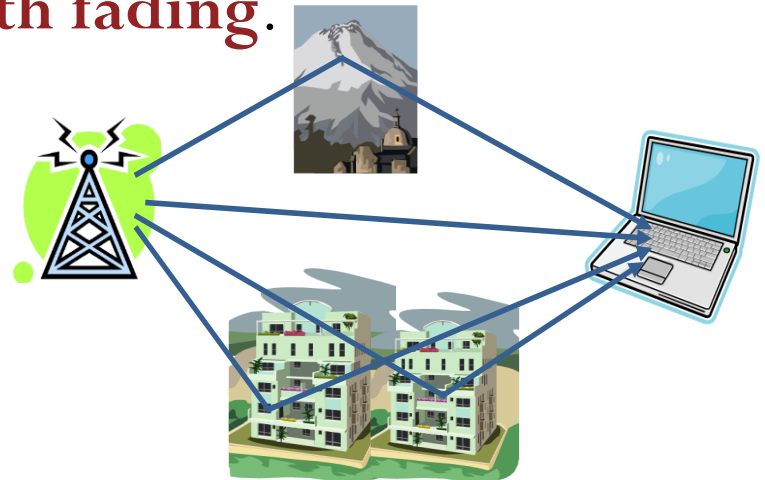

Similar Problem: Ghosting



Wireless Comm. and Multipath Fading

The signal received consists of a number of reflected rays, each characterized by a different amount of attenuation and delay.

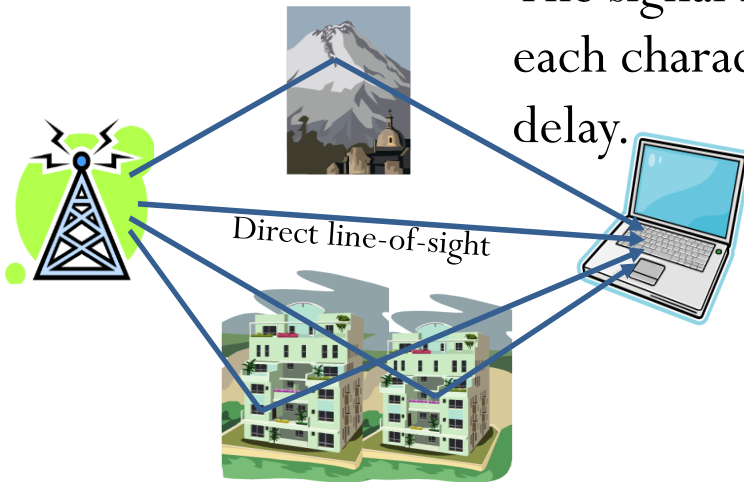

$$r(t) = x(t) * h(t) + n(t) = \sum_{i=0}^v \beta_i x(t - \tau_i) + n(t)$$

$$h(t) = \sum_{i=0}^v \beta_i \delta(t - \tau_i)$$

$$h_1(t) = 0.5\delta(t) + 0.2\delta(t - 0.2T_s) + 0.3\delta(t - 0.3T_s) + 0.1\delta(t - 0.5T_s)$$

$$h_2(t) = 0.5\delta(t) + 0.2\delta(t - 0.7T_s) + 0.3\delta(t - 1.5T_s) + 0.1\delta(t - 2.3T_s)$$

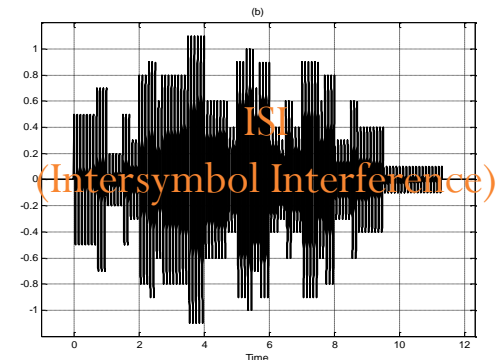
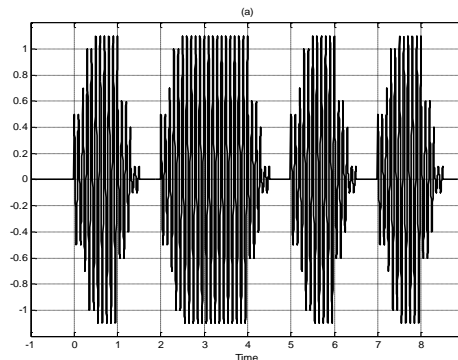
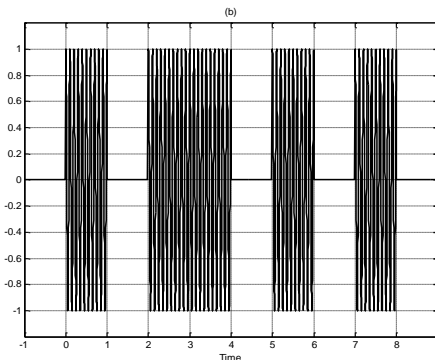

Frequency Domain

The transmitted signal (envelope)

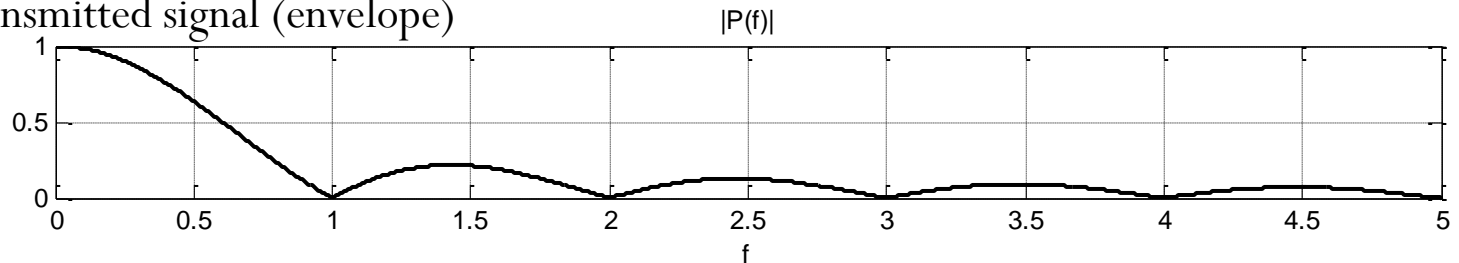

Channel with weak multipath

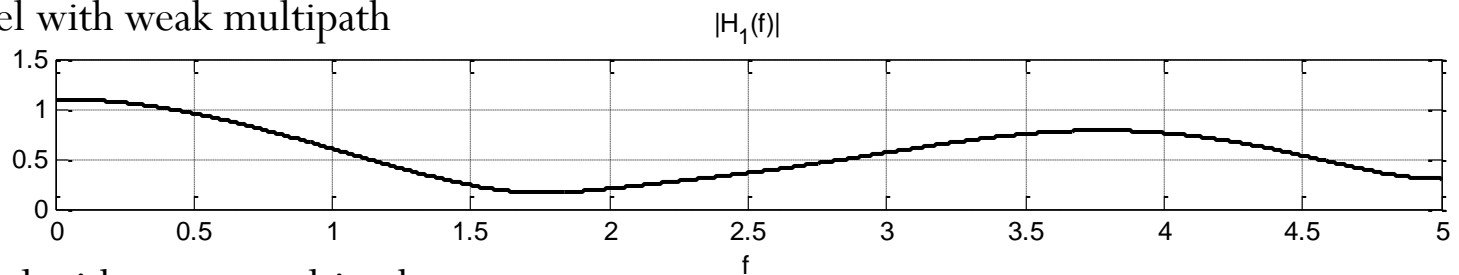

Channel with strong multipath

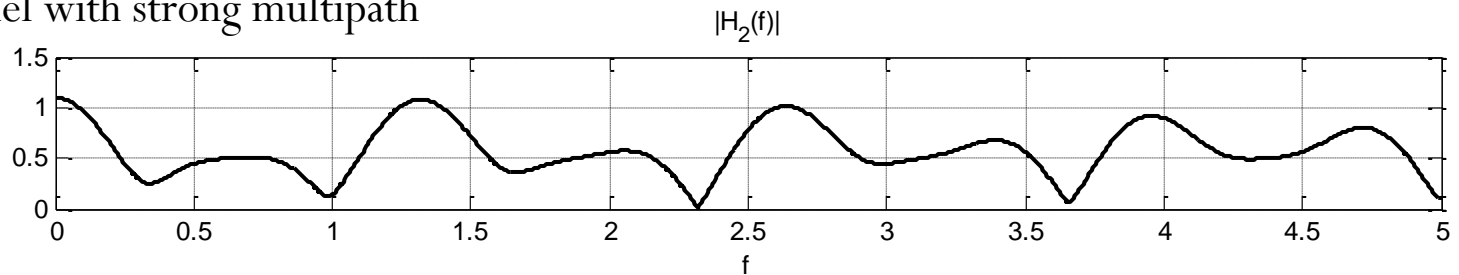

COST 207 Channel Model

- Based on channel measurements with a bandwidth of 8–10MHz in the 900MHz band used for 2G systems such as GSM.

Path #	Rural Area (RA)		Typical Urban (TU)		Bad Urban (BU)		Hilly Terrain (HT)	
	Delay	Power	Delay	Power	Delay	Power	Delay	Power
	(μ s)	(dB)	(μ s)	(dB)	(μ s)	(dB)	(μ s)	(dB)
1	0	0	0	-3	0	-2.5	0	0
2	0.1	-4	0.2	0	0.3	0	0.1	-1.5
3	0.2	-8	0.5	-2	1.0	-3	0.3	-4.5
4	0.3	-12	1.6	-6	1.6	-5	0.5	-7.5
5	0.4	-16	2.3	-8	5.0	-2	15.0	-8.0
6	0.5	-20	5.0	-10	6.6	-4	17.2	-17.7

3GPP LTE Channel Models

Path number	Extended Pedestrian A (EPA)		Extended Vehicular A (EVA)		Extended Typical Urban (ETU)	
	Delay	Power	Delay	Power	Delay	Power
	(ns)	(dB)	(ns)	(dB)	(ns)	(dB)
1	0	0	0	0	0	-1
2	30	-1	30	-1.5	50	-1
3	70	-2	150	-1.4	120	-1
4	90	-3	310	-3.6	200	0
5	110	-8	370	-0.6	230	0
6	190	-17.2	710	-9.1	500	0
7	410	-20.8	1090	-7	1600	-3
8			1730	-12	2300	-5
9			2510	-16.9	5000	-7

3GPP 6-tap typical urban (TU6)

- Delay profile and frequency response of 3GPP 6-tap typical urban (TU6) Rayleigh fading channel in 5 MHz band.

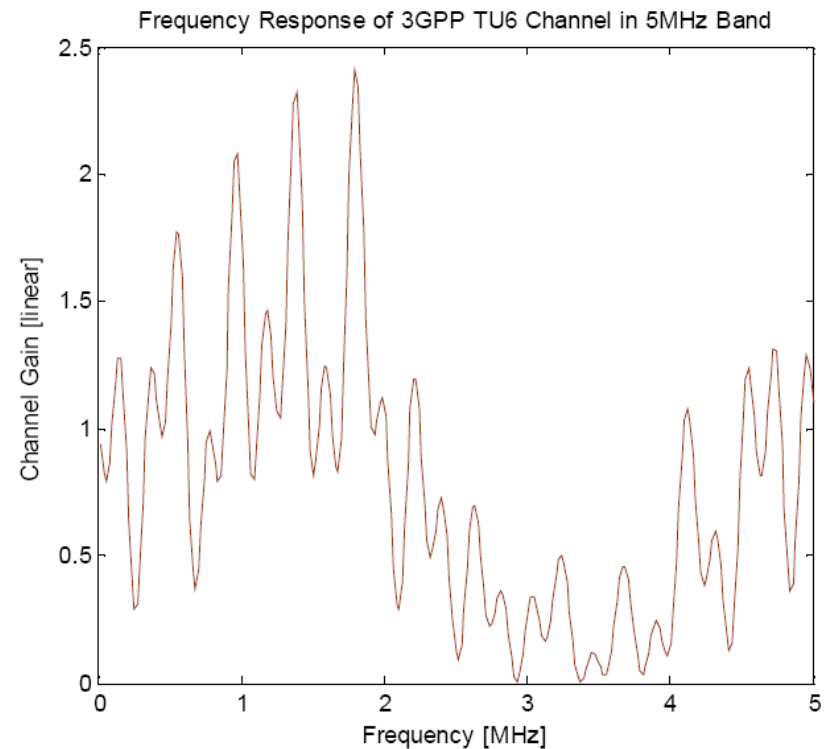
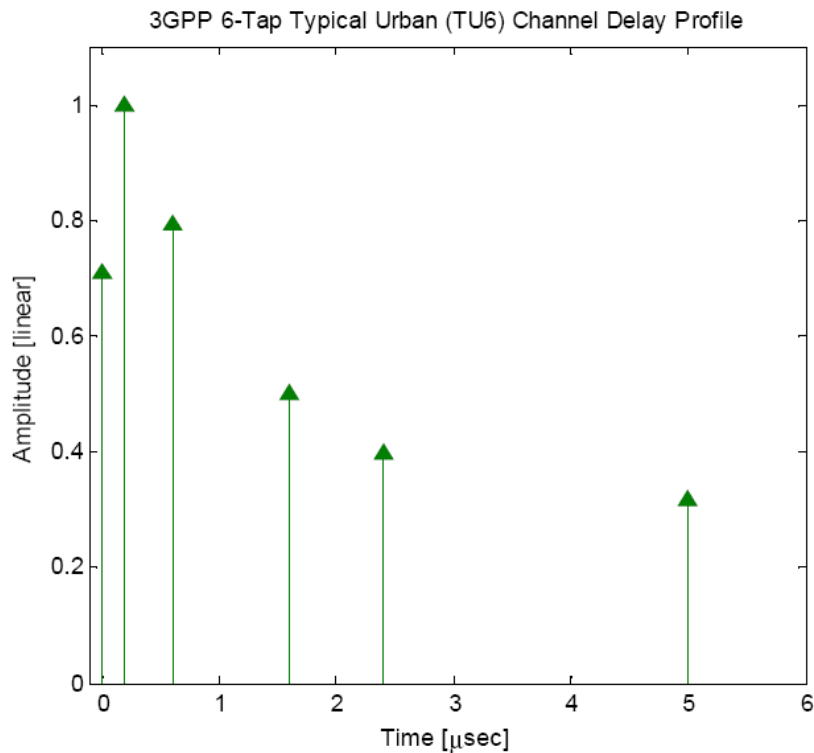

Equalization

- Chapter 11 of [Goldsmith, 2005]
- Delay spread causes ISI
- In a broad sense, **equalization** defines any signal processing technique used at the *receiver* to alleviate the ISI problem caused by delay spread. [Goldsmith, 2005]
- Higher data rate applications are more sensitive to delay spread, and generally require high-performance equalizers or other ISI mitigation techniques.
- Signal processing can also be used at the *transmitter* to make the signal less susceptible to delay spread.
 - Ex. spread spectrum and multicarrier modulation

Equalizer design

- Need to **balance ISI mitigation with noise enhancement**
 - Both the signal and the noise pass through the equalizer
- Nonlinear equalizers suffer less from noise enhancement than linear equalizers, but typically entail higher complexity.
- Most equalizers are implemented digitally after A/D conversion
 - Such filters are small, cheap, easily tuneable, and very power efficient.
- The *optimal* equalization technique is **maximum likelihood sequence estimation (MLSE)**.
 - Unfortunately, the complexity of this technique (even when using **Viterbi algorithm**) grows exponentially with the length of the delay spread, and is therefore *impractical* on most channels of interest.

Simple Analog Equalizer

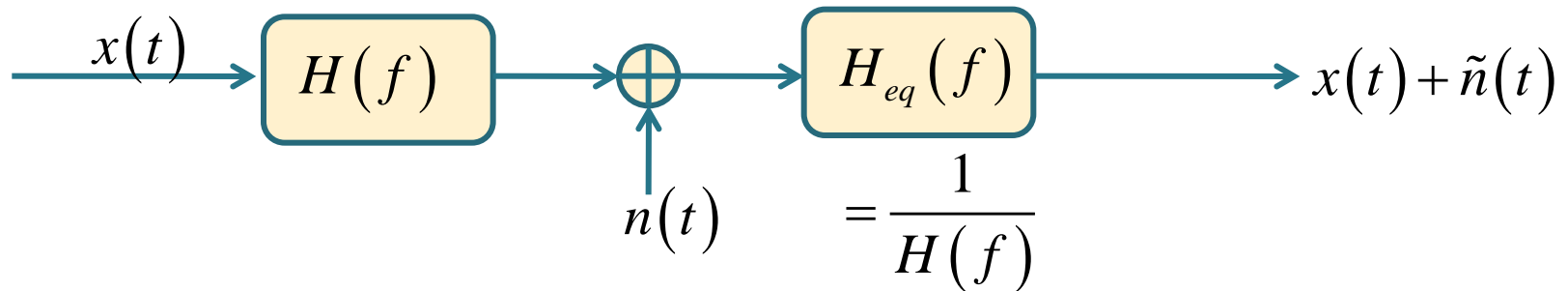

- Attempt to *remove all ISI*
- Disadvantages:
 - If some frequencies in the channel frequency response $H(f)$ are greatly attenuated, the equalizer $H_{eq}(f) = 1/H(f)$ will greatly enhance the noise power at those frequencies.
 - If the channel frequency response $H(f)$ has a spectral null ($= 0$ for some frequency), then the power of the new noise is infinite.
- Even though the ISI effects are (completely) removed, the equalized system will perform poorly due to its greatly reduced SNR.

Linear vs. Non-linear Equalizers

- Need to balance mitigation of the effects of ISI with maximizing the SNR of the post-equalization signal.
- **Linear** digital equalizers
 - In general work by inverting the channel frequency response
 - Easy to implement and to understand conceptually
 - Typically suffer from more noise enhancement
 - Not used in most wireless applications
- **Nonlinear** equalizers
 - Do not invert the channel frequency response
 - Suffer much less from noise enhancement
 - **Decision-feedback equalization (DFE)** is the most common
 - Fairly simple to implement and generally performs well.

Equalizer Types

Symbol-by-symbol (SBS) equalizers: remove ISI from each symbol and then detect each symbol individually.

Sequence estimators (SE): detect sequences of symbols, so the effect of ISI is part of the estimation process.

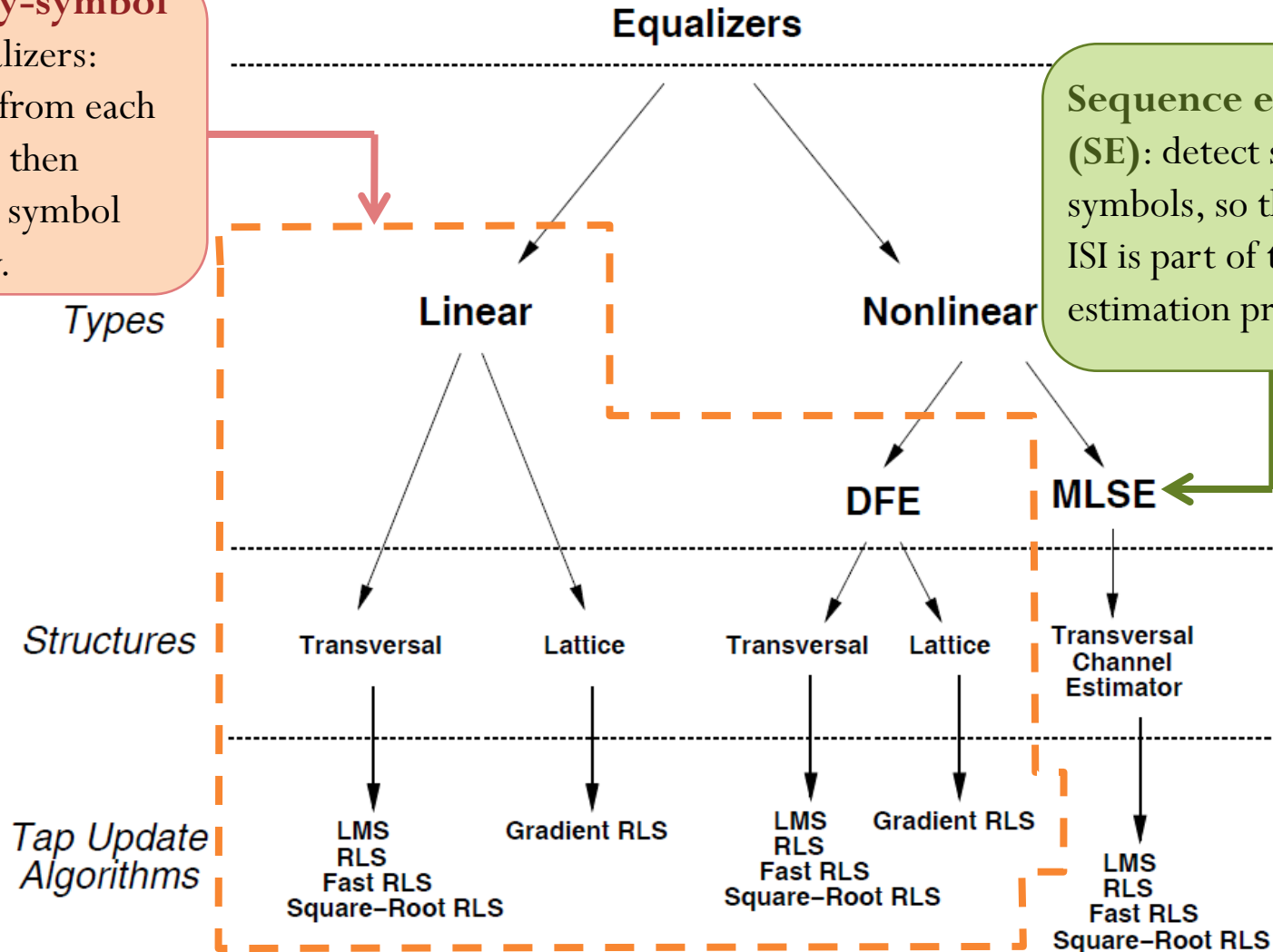

Transversal Structure

- Linear and nonlinear equalizers are typically implemented using a transversal or lattice structure.
- The transversal structure is a filter with $N - 1$ delay elements and N taps with tunable complex weights.

$$H_{eq}(z) = \sum_{i=-L}^L w_i z^{-i}$$

$$N = 2L + 1$$

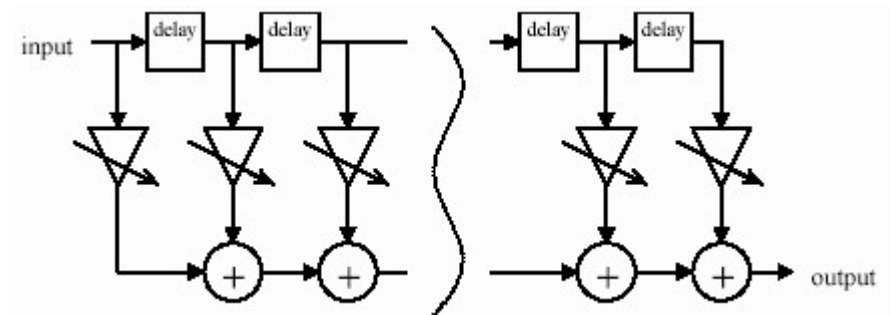

- The length of the equalizer N is typically dictated by implementation considerations
 - Large N usually entails higher complexity.

Time-varying Multipath Channel

- Impulse Response:

$$h(\tau, t) = \sum_{i=0}^{L-1} \beta_i(t) \delta(\tau - \tau_i)$$

- $L =$ number of resolvable paths

- $\beta_i(t) =$ complex-valued path gain of the i th path

- Usually assumed to be independent complex Gaussian processes resulting in Rayleigh fading because each resolvable path is the contribution of a different group of many irresolvable paths.

- $\tau_i =$ time delay of the i th path

- Transfer function: $H(f, t)$

$L = 16$ -path exponential power delay profile with a decay factor of 1.0 dB and a time delay separation of 150 ns between adjacent paths (corresponding to the rms delay spread of 0.52 μ s). 5 GHz carrier frequency and 4 km/h terminal speed.

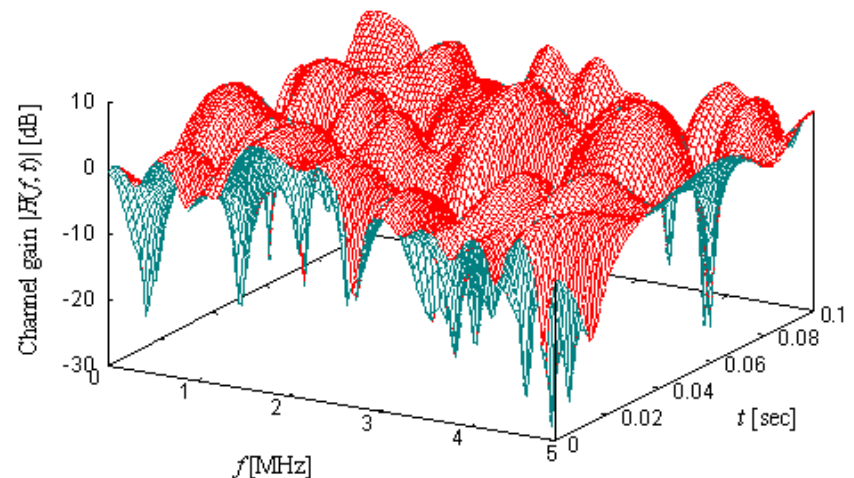

[Adachi, Garg, Takaoka, and Takeda, 2005, Figure 2]

Adaptive Equalization

- Equalizers must typically have an estimate of the channel (impulse or frequency response)
 - Since the wireless channel varies over time, the equalizer must
 - learn the frequency or impulse response of the channel (**training**)
 - and then update its estimate of the frequency response as the channel changes
- The process of equalizer training and tracking is often referred to as **adaptive equalization**.
- **Blind equalizers** do not use training
 - Learn the channel response via the detected data only

Equalization for Digital Cellular Telephony

- GSM
 - Use adaptive equalizer
 - Equalize echos up to 16 ms after the first signal received
 - Correspond to 4.8 km in distance.
 - One bit period is 3.69 ms. Hence, echos with about 4 bit lengths delay can be compensated
- The direct sequence spreading employed by CDMA (IS-95) obviates the need for a traditional equalizer.
- If the transmission bandwidth is large (for example 20 MHz), the complexity of straightforward high-performance equalization starts to become a serious issue.



Wireless Propagation

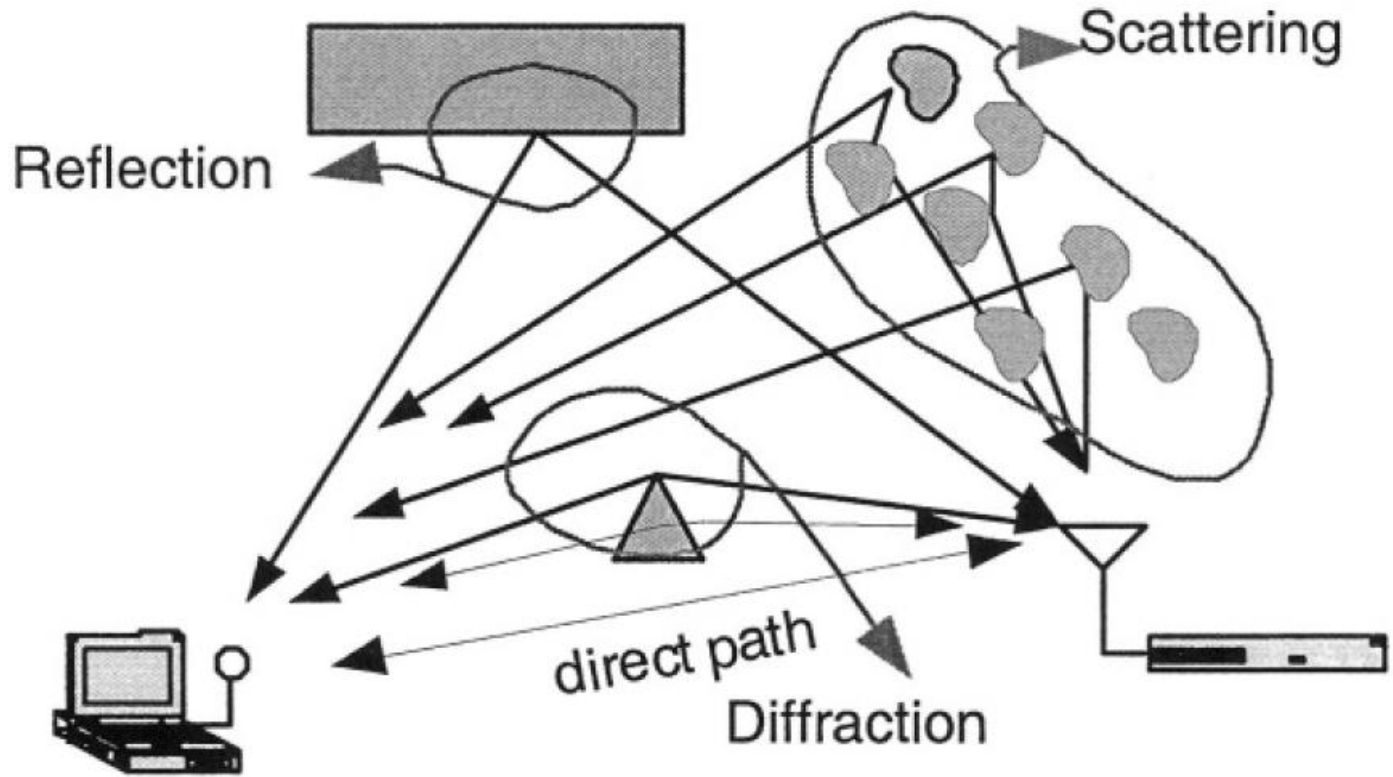

[Bahai, 2002, Fig. 2.1]

Three steps towards modern OFDM

1. Mitigate Multipath problem
→ Multicarrier modulation (FDM)
2. Gain Spectral Efficiency
→ Orthogonality of the carriers
3. Achieve Efficient Implementation
→ FFT and IFFT

ECS455: Chapter 5

OFDM

5.2 Multi-Carrier Transmission

Dr. Prapun Suksompong
prapun.com/ecs455

Office Hours:
BKD 3601-7
Tuesday 9:30-10:30
Friday 14:00-16:00

Single-Carrier Transmission

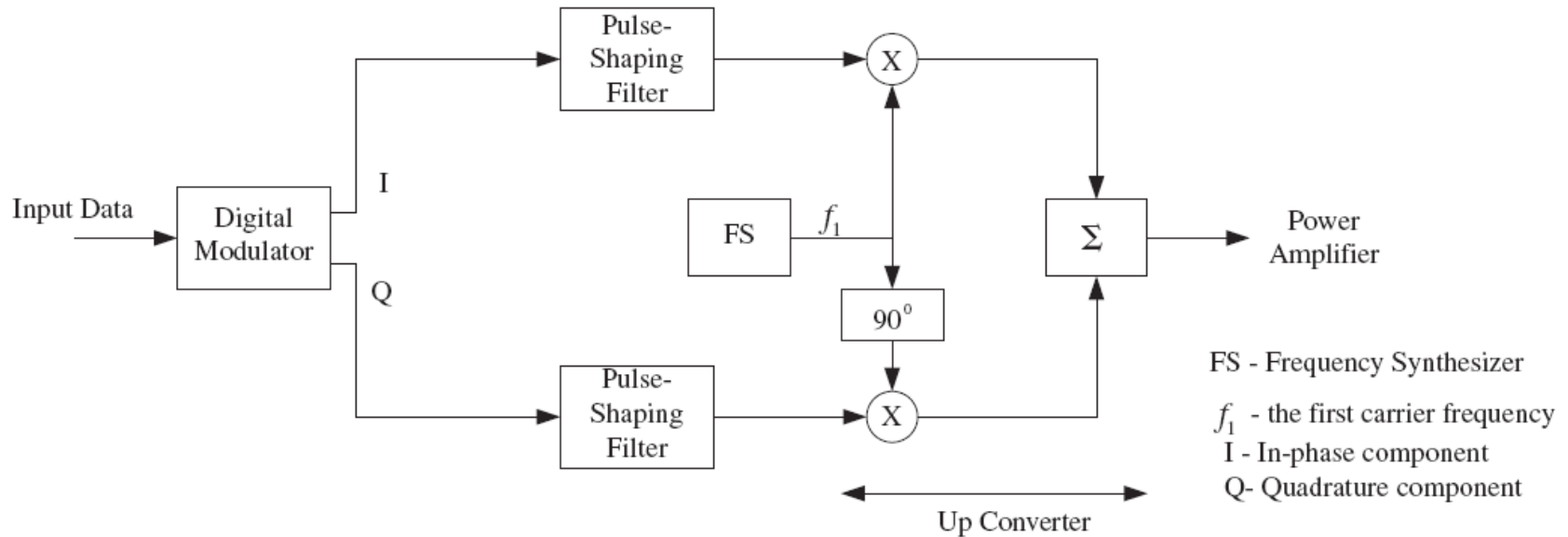

[Karim and Sarraf, 2002, Fig 3-1]

$$\begin{aligned}
 & \text{In-phase component} \quad \text{Quadrature component} \\
 s(t) &= S_I p_I(t) \cos(\omega_c t) - S_Q p_Q(t) \sin(\omega_c t) \\
 &= \text{Re} \left\{ \left(S_I p_I(t) + j S_Q p_Q(t) \right) e^{j\omega_c t} \right\}
 \end{aligned}$$

Multi-Carrier Transmission

- Convert a serial high rate data stream on to **multiple parallel low rate** sub-streams.
- Each sub-stream is modulated on its own sub-carrier.
- **Time domain perspective**: Since the symbol rate on each sub-carrier is much less than the initial serial data symbol rate, the effects of delay spread, i.e. ISI, significantly decrease, reducing the complexity of the equalizer.

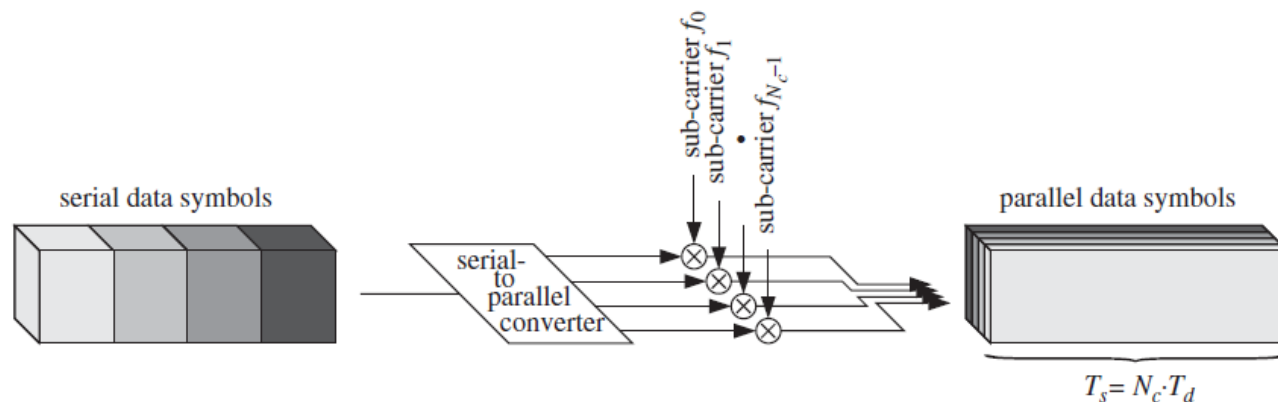

[Fazel and Kaiser, 2008, Fig 1-4]

Frequency Division Multiplexing

- **Frequency Domain Perspective**: Even though the fast fading is frequency-selective across the entire OFDM signal band, it is effectively flat in the band of each low-speed signal.

[The flatness assumption is the same one that you used in Riemann approximation of integral.]

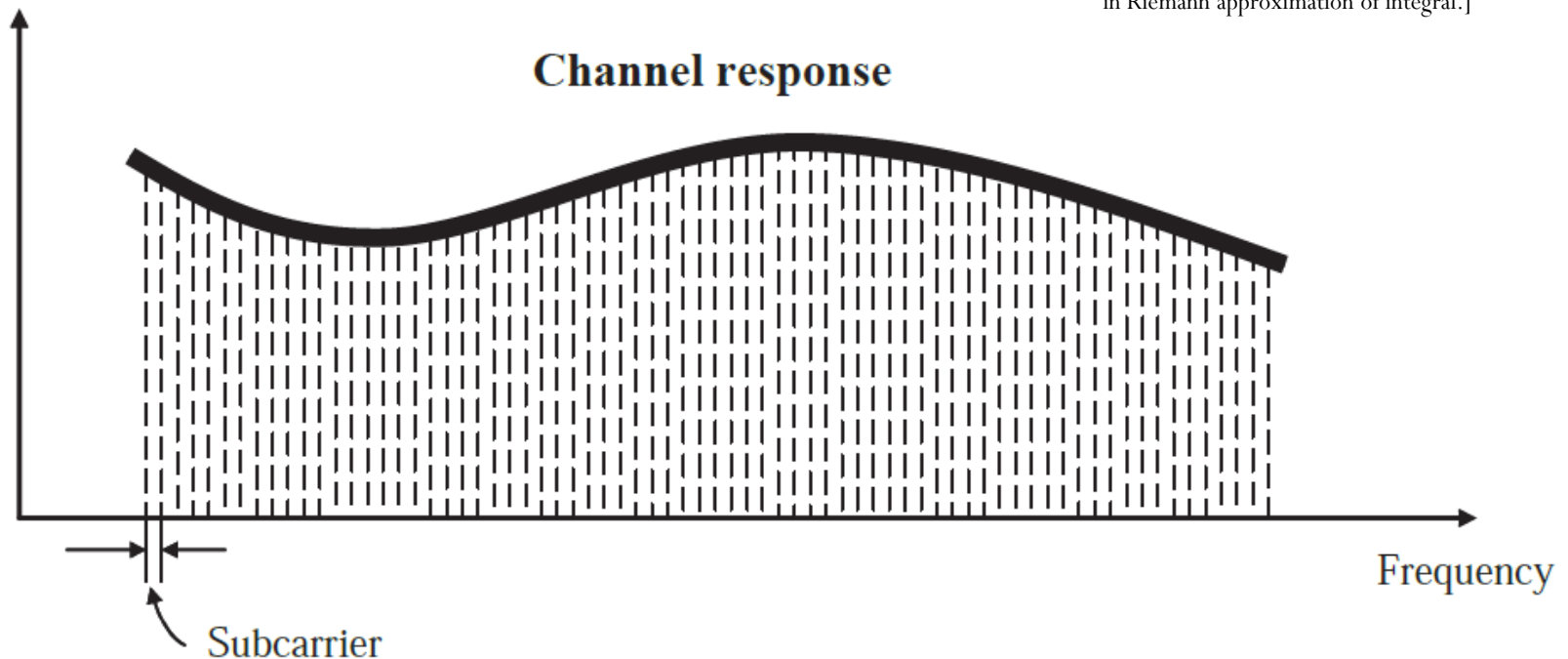

Frequency Division Multiplexing

- To facilitate separation of the signals at the receiver, the carrier frequencies were **spaced sufficiently far apart** so that the signal spectra did not overlap. Empty spectral regions between the signals assured that they could be separated with readily realizable filters.
- The resulting spectral efficiency was therefore quite low.

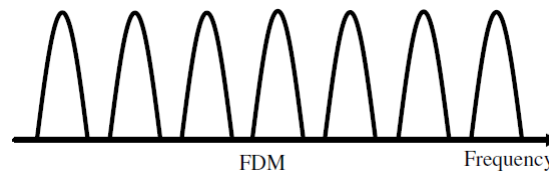

Multi-Carrier (FDM) vs. Single Carrier

Single Carrier	Multi-Carrier (FDM)
Single higher rate serial scheme	Parallel scheme. Each of the parallel subchannels can carry a low signalling rate, proportional to its bandwidth.
<ul style="list-style-type: none">○ Multipath problem: Far more susceptible to inter-symbol interference (ISI) due to the short duration of its signal elements and the higher distortion produced by its wider frequency band○ Complicated equalization	<ul style="list-style-type: none">○ Long duration signal elements and narrow bandwidth in sub-channels.○ Complexity problem: If built straightforwardly as several (N) transmitters and receivers, will be more costly to implement.○ BW efficiency problem: The sum of parallel signalling rates is less than can be carried by a single serial channel of that combined bandwidth because of the unused guard space between the parallel sub-carriers.

FDM (con't)

- Before the development of equalization, the parallel technique was the preferred means of achieving high rates over a dispersive channel, in spite of its high cost and relative bandwidth inefficiency.

OFDM

- OFDM = Orthogonal frequency division multiplexing
- One of multi-carrier modulation (MCM) techniques
 - Parallel data transmission (of many sequential streams)
 - A broadband is divided into many narrow sub-channels
 - Frequency division multiplexing (FDM)
- High spectral efficiency
 - The sub-channels are made orthogonal to each other over the OFDM symbol duration T_s .
 - Spacing is carefully selected.
 - Allow the sub-channels to overlap in the frequency domain.
 - Allow sub-carriers to be spaced as close as theoretically possible.

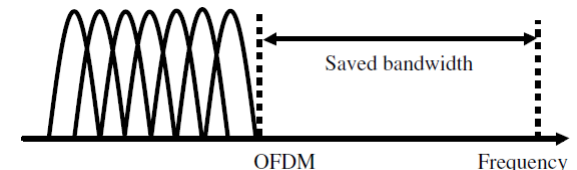
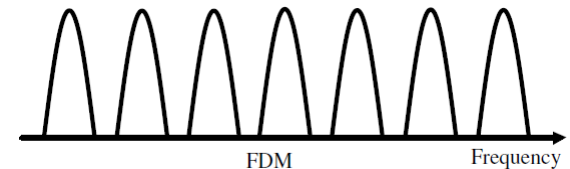

OFDM

- Recall: Orthogonality-Based MA (CDMA)

$$s(t) = \sum_{k=0}^{\ell-1} S_k c_k(t) \quad \text{where } c_{k_1} \perp c_{k_2}$$

- Discrete baseband OFDM modulated symbol:

$$\begin{aligned} s(t) &= \frac{1}{\sqrt{N}} \sum_{k=0}^{N-1} S_k \exp\left(j \frac{2\pi kt}{T_s}\right), \quad 0 \leq t \leq T_s \\ &= \sum_{k=0}^{N-1} S_k \underbrace{\frac{1}{\sqrt{N}} 1_{[0, T_s]}(t) \exp\left(j \frac{2\pi kt}{T_s}\right)}_{c_k(t)} \end{aligned}$$

Another special case of CDMA!

OFDM: Orthogonality

$$\begin{aligned}\int c_{k_1}(t) c_{k_2}^*(t) dt &= \int_0^{T_s} \exp\left(j \frac{2\pi k_1 t}{T_s}\right) \exp\left(-j \frac{2\pi k_2 t}{T_s}\right) dt \\ &= \int_0^{T_s} \exp\left(j \frac{2\pi (k_1 - k_2) t}{T_s}\right) dt = \begin{cases} T_s, & k_1 = k_2 \\ 0, & k_1 \neq k_2 \end{cases}\end{aligned}$$

When $k_1 = k_2$,

$$\int c_{k_1}(t) c_{k_2}^*(t) dt = \int_0^{T_s} 1 dt = T_s$$

When $k_1 \neq k_2$,

$$\begin{aligned}\int c_{k_1}(t) c_{k_2}^*(t) dt &= \frac{T_s}{j2\pi(k_1 - k_2)} \exp\left(j \frac{2\pi(k_1 - k_2)t}{T_s}\right) \Bigg|_0^{T_s} \\ &= \frac{T_s}{j2\pi(k_1 - k_2)} (1 - 1) = 0\end{aligned}$$

Frequency Spectrum

$$s(t) = \sum_{k=0}^{N-1} S_k \underbrace{\frac{1}{\sqrt{N}} 1_{[0, T_s]}(t) \exp\left(j \frac{2\pi k t}{T_s}\right)}_{c_k(t)}$$

$$\Delta f = \frac{1}{T_s}$$

This is the term that makes the technique FDM.

$$1_{\left[-\frac{T_s}{2}, \frac{T_s}{2}\right]}(t) \xrightarrow{\mathcal{F}} T_s \operatorname{sinc}(\pi T_s f)$$

$$c(t) = \frac{1}{\sqrt{N}} 1_{[0, T_s]}(t) \xrightarrow{\mathcal{F}} C(f) = \frac{1}{\sqrt{N}} T_s e^{-j2\pi f \frac{T_s}{2}} \operatorname{sinc}(\pi T_s f)$$

$$c_k(t) = c(t) \exp\left(j \frac{2\pi k t}{T_s}\right) \xrightarrow{\mathcal{F}} C_k(f) = C\left(f - \frac{k}{T_s}\right) = C(f - k\Delta f)$$

$$s(t) = \sum_{k=0}^{N-1} S_k c_k(t) \xrightarrow{\mathcal{F}} S(f) = \sum_{k=0}^{N-1} S_k C_k(f) = \frac{1}{\sqrt{N}} \sum_{k=0}^{N-1} S_k e^{-j2\pi(f - k\Delta f) \frac{T_s}{2}} T_s \operatorname{sinc}(\pi T_s (f - k\Delta f))$$

Subcarrier Spacing

$$s(t) = \sum_{k=0}^{N-1} S_k \frac{1}{\sqrt{N}} 1_{[0, T_s]}(t) \exp\left(j \frac{2\pi k t}{T_s}\right)$$
$$S(f) = \frac{1}{\sqrt{N}} \sum_{k=0}^{N-1} S_k e^{-j 2\pi (f - k \Delta f) \frac{T_s}{2}} T_s \operatorname{sinc}(\pi T_s (f - k \Delta f))$$

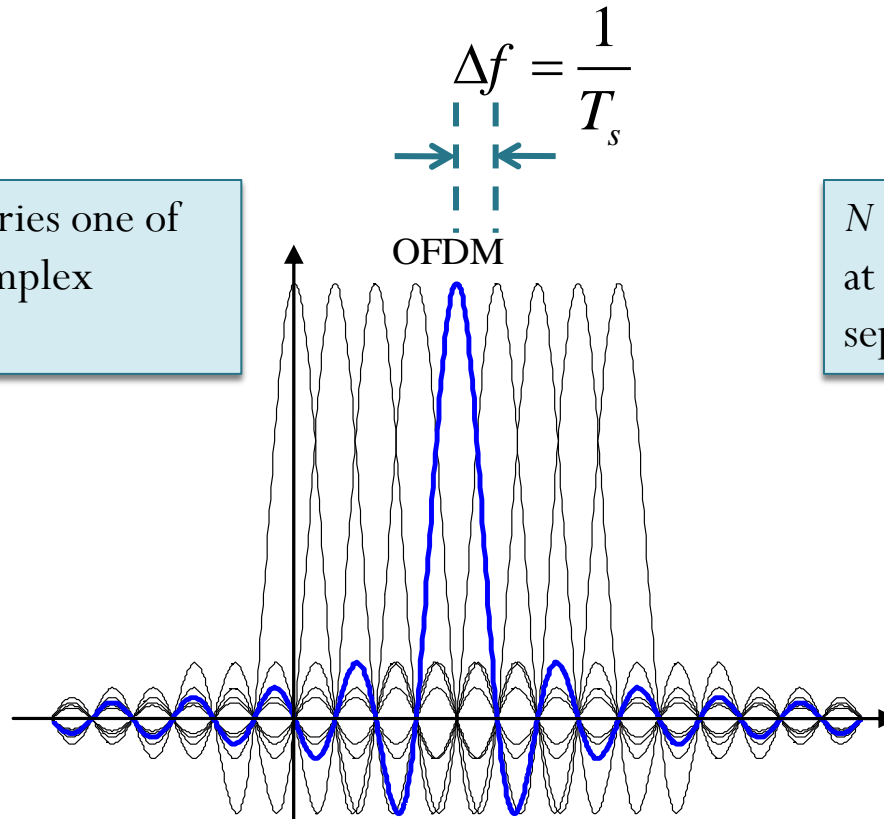

Each QAM signal carries one of the original input complex numbers.

N separate QAM signals, at N frequencies separated by the signaling rate.

The spectrum of each QAM signal is of the form with nulls at the center of the other subcarriers.

Spectrum Overlap in OFDM

Normalized Power Density Spectrum

Flatter when have more sub-carriers

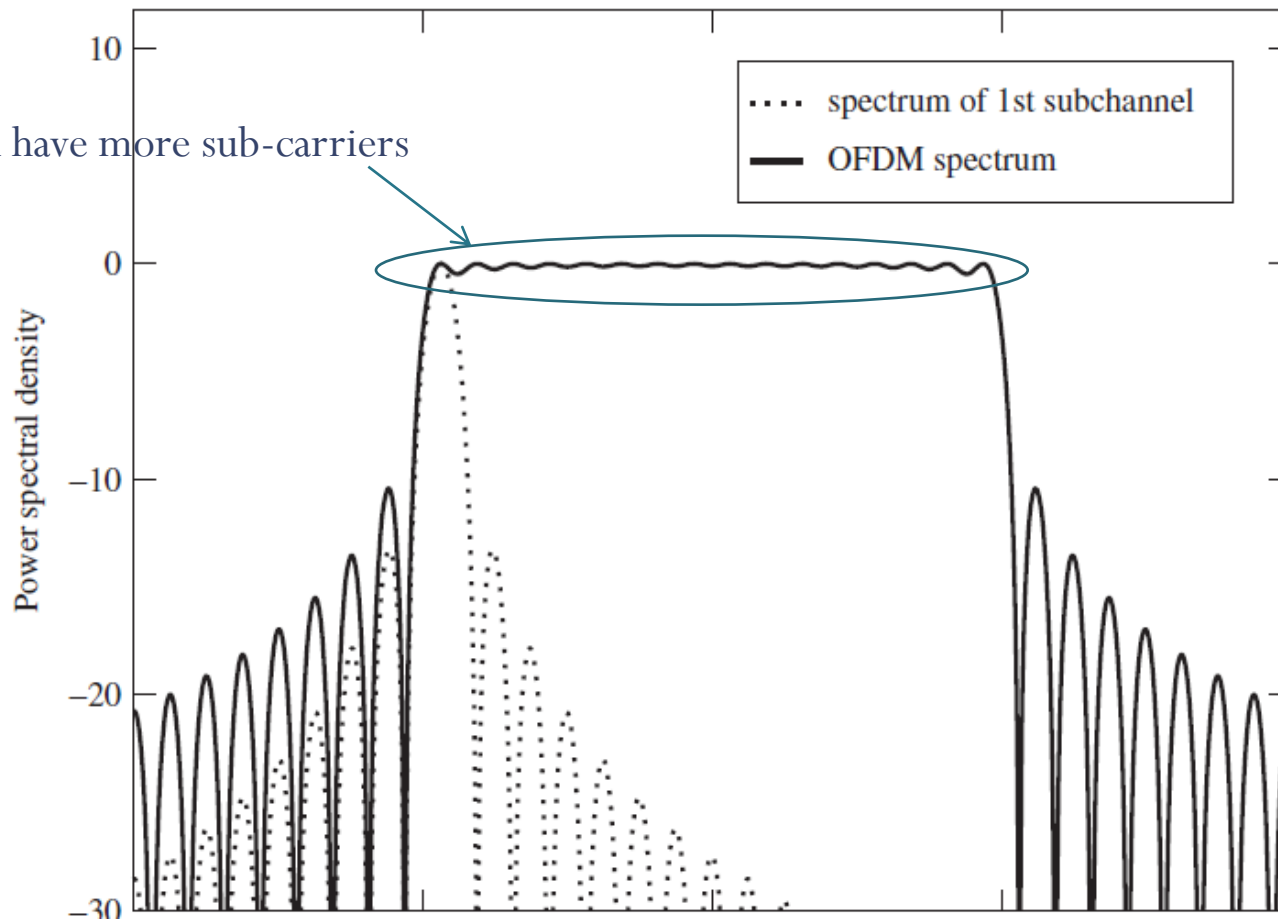

[Fazel and Kaiser, 2008, Fig 1-5]

OFDM Carriers: $N = 4$

$$\cos\left(\frac{2\pi kt}{T_s}\right)$$

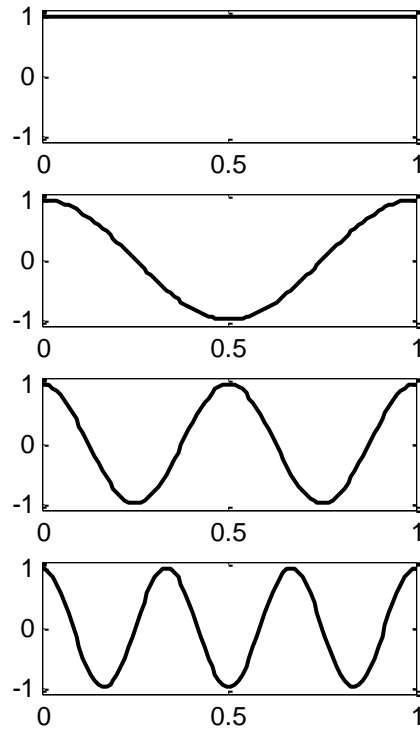

$$\sin\left(\frac{2\pi kt}{T_s}\right)$$

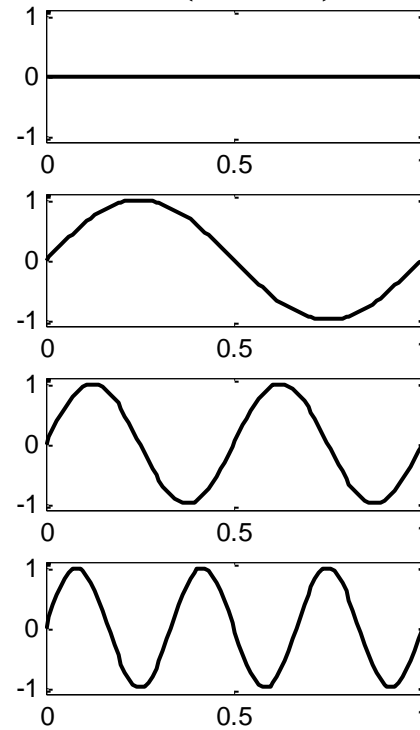

OFDM as a Multicarrier Technique

$$\text{Re}\{s(t)\} = \frac{1}{\sqrt{N}} \sum_{k=0}^{N-1} \left(\text{Re}\{S_k\} \cos\left(\frac{2\pi kt}{T_s}\right) - \text{Im}\{S_k\} \sin\left(\frac{2\pi kt}{T_s}\right) \right)$$

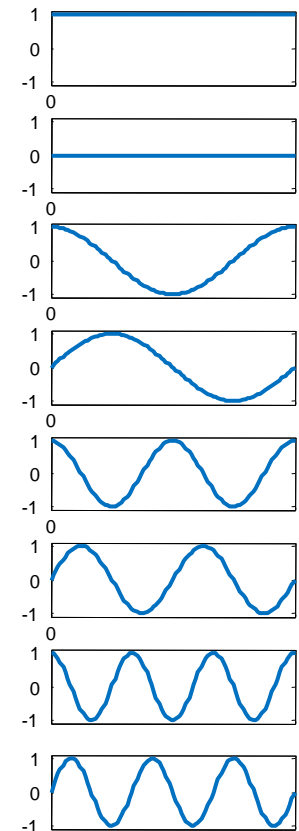

Time-Domain Signal

Real component of an OFDM signal

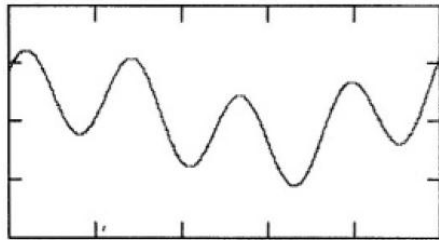
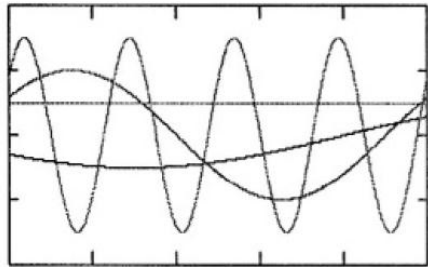

Imaginary component of an OFDM signal

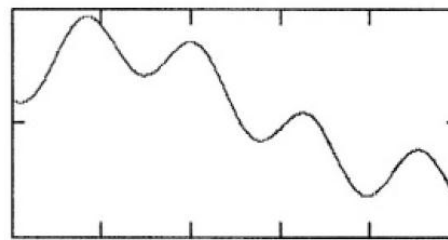
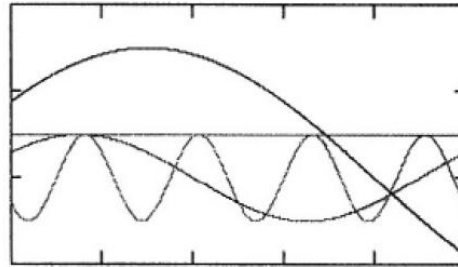

Real and Imaginary components of an OFDM symbol is the superposition of several harmonics modulated by data symbols

[Bahai, 2002, Fig 1.7]

$$s(t) = \frac{1}{\sqrt{N}} \sum_{k=0}^{N-1} S_k \exp\left(j \frac{2\pi kt}{T_s}\right), \quad 0 \leq t \leq T_s$$

$$\text{Re}\{s(t)\} = \frac{1}{\sqrt{N}} \sum_{k=0}^{N-1} \left(\underbrace{\text{Re}\{S_k\} \cos\left(\frac{2\pi kt}{T_s}\right)}_{\text{in-phase part}} - \underbrace{\text{Im}\{S_k\} \sin\left(\frac{2\pi kt}{T_s}\right)}_{\text{quadrature part}} \right)$$

Summary

- So, we have a scheme which achieves
 - Large symbol duration (T_s) and hence less multipath problem
 - Good spectral efficiency
- One more problem:
 - There are so many carriers!